

ERT100 Digital Earth Resistance Tester

OPERATING INSTRUCTION

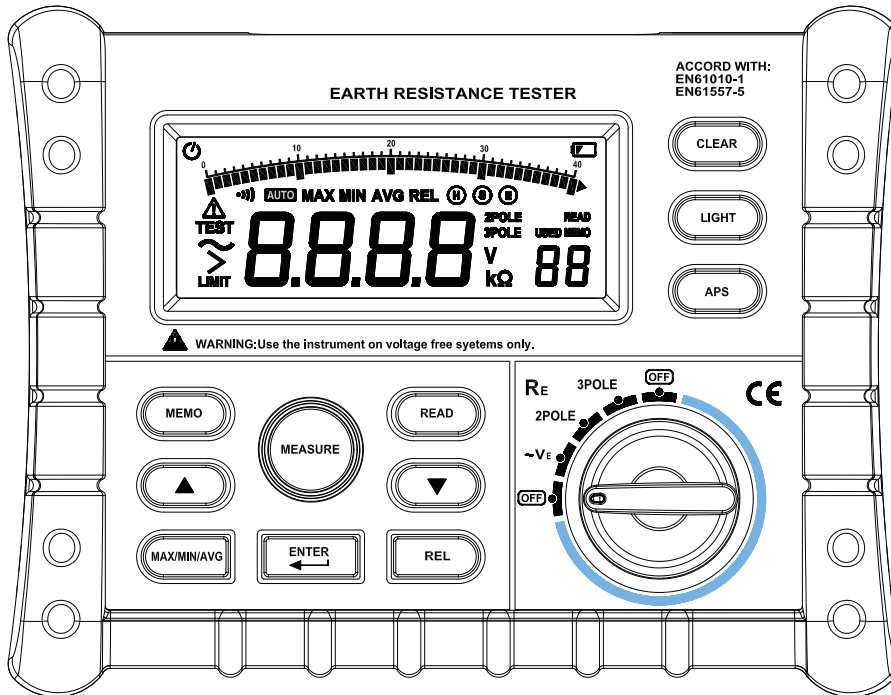

ERT100 Digital Earth Resistance Tester

Contents

1. Safety.....	1
2. Description.....	2
2.1 Meter Description.....	2
2.2 Display.....	5
3. Specifications.....	7
3.1 Range and Precision.....	7
3.2 Measurement Method.....	7
3.3 Using Temperature and Humidity.....	7
3.4 Storing Temperature and Humidity.....	7
3.5 Battery.....	7
3.6 Volume.....	7
3.7 Weight.....	7
3.8 Accessories.....	7

ERT100 Digital Earth Resistance Tester

4.Operation Instructions	8
4.1 Testing for Earth Voltage.....	8
4.2 Testing the Earth Resistance using the 2-pole method.....	8
4.3 Testing the Earth Resistance using the 3-pole method.....	10
4.4 Data Storage	12
4.5 Data Recall.....	12
4.6 REL Measurement.....	13
4.7 MAX/MIN/AVG Measurement.....	13
4.8 Data Deletion.....	13
4.9 Back Light.....	13
4.10 Auto Off.....	13
5.Battery Replacement	14





ERT100 Digital Earth Resistance Tester

1. Safety

The earth resistance tester (hereinafter referred to as meter) , which is up to GB4793.1, the requirement on the safety of electronic measurement instruments, is designed and manufactured in accordance with EN 61010-1, EN61010-2-030 Safety Standard, regarded as Grade 2 pollution, and the maximum voltage for the meter to probe can not exceed CAT III 300V.

The users' manual includes cautions and safety regulations which specifies the rules in usage of the meter to avoid personal injury accident. Please read the manual before using the meter and adhere to the operation instructions inside it. Failure to follow instructions in the manual in using the meter may cause personal injury or damage to the meter.

Safety Symbols

-  Danger: improper operation will cause severe or fatal injuries.
-  Warning: improper operation may cause severe or fatal injuries
-  Caution : improper operation may cause personal injuries or damage to the meter
-  Equipment protected throughout by double insulation or reinforced insulation

CAT III (measurement category III): Applicable to test and measuring circuits connected to the distribution part of the building's low-voltage MAINS installation.

Danger

Check if the rotating switch is set to a proper position before measurement

Never use the meter in the vicinity of explosive gases, steam or dust.

Never connect wires or probes with wet hands or when the surface of the meter is wet.

Don't touch the testing wires or probes while measuring.

Don't open the battery cover when the meter is working.

Warning

Never make measurements in abnormal conditions, for example, the housing of the meter has been damaged so that the metal of the meter or wires are exposed.

Never replace the parts of the meter by yourself or modify it. Should the meter be damaged, return it to the local dealers for examination or repair. Don't replace the batteries when the surface of the meter is humid.

Be sure to set the switch to "OFF" and disconnect the testing wires before replacing the batteries.

ERT100 Digital Earth Resistance Tester

Caution

Check if the total length of testing plugs are inserted into the port before a measurement.
Take out of the batteries from the cartridge if the meter will not be used or will be stored for long.
Don't expose the meter to sunlight, high temperature, humidity or dew
Clean the meter with neutral solvents or wet cloth instead of abrasives or organic solvents
Lay the meter in store only when it is dry.

Caution:

Using this appliance in an environment with a strong radiated radio-frequency electromagnetic field (approximately 3V/m), may influence its measuring accuracy. The measuring result can be strongly deviating from the actual value.

2. Description

The meter is applicable to the testing of the earth resistance of power supply wires, distribution wires inside a room, electrical equipment or appliance, which can done in two measurement modes: 2-pole or 3-pole, and it also can be used to measure the earth voltage. Large digital LCD and backlights applied to the meter facilitate users to read the information on LCD. Besides, the meter is capable of storing up to 100 groups of measurement data, which will not be lost even in case of power cuts so that the user can easily consult the historical data. In addition, the meter can also be used to measure maximum, minimum or average and measure relatively. Auto power-off function has been provided.

2.1 Meter Description

(1) Rotating Switch

It is used to select between the measurement of earth voltage, measurement of resistance in 2-pole method or measurement of resistance in 3-pole method.

(2) ASP Key

Used to start or cease auto power-off function.

(3) LIGHT Key

Used to turn on or turn off the backlight.

(4) CLEAR Key

It is used to clear away data.

(5) LCD

It is used to display the data obtained and different symbols.

ERT100 Digital Earth Resistance Tester

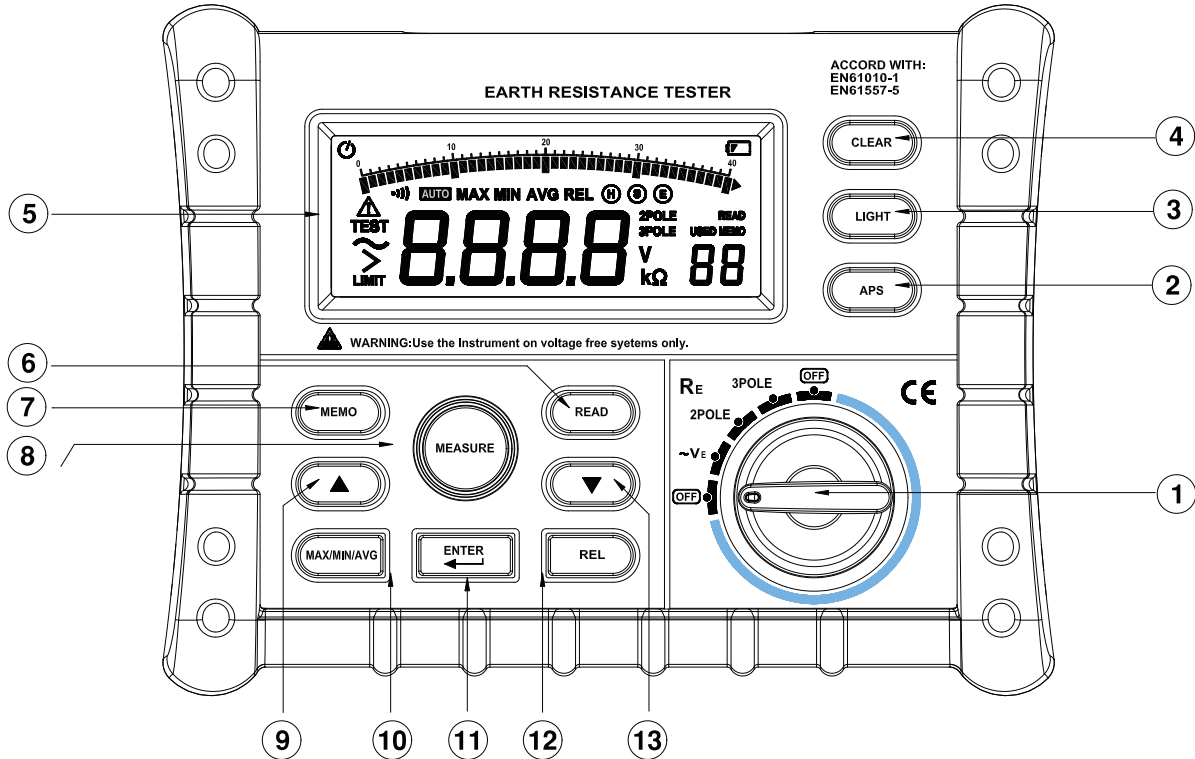

ERT100 Digital Earth Resistance Tester

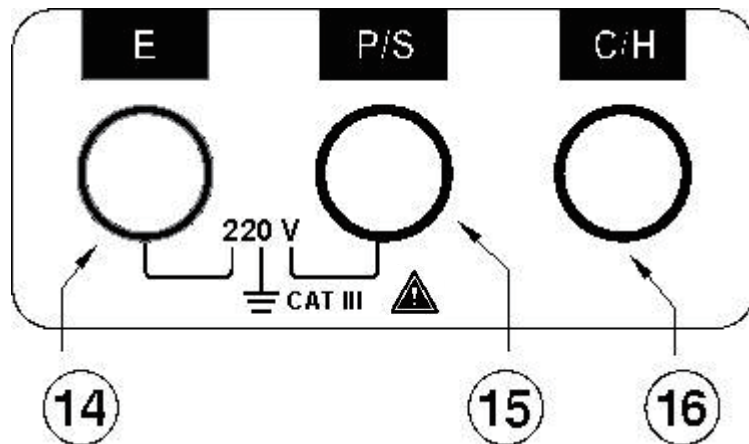

(6) READ Key

It is used to read the data obtained.

(7) MEMO Key

It is used to store the data obtained.

(8) Measure Key

Used to start or stop a measurement of resistance.

(9) ▲ Key

It is used to select a memory for storage of data obtained.

(10) MAX/MIN/AVG Key

Used to switch between the measurement of maximum, minimum and average.

(11) ENTER Key

Used to confirm a storage or reading of data.

(12) REL Key

Used to select relative measurement.

(13) ▼ Key

Used to select a memory for storage of data obtained.

(14) E socket

Used to connect with the grounding pole.

(15) P/S socket

Used to connect with the auxiliary grounding pole.

(16) C/H socket

Used to connect with the auxiliary grounding pole.

ERT100 Digital Earth Resistance Tester

2.2 LCD

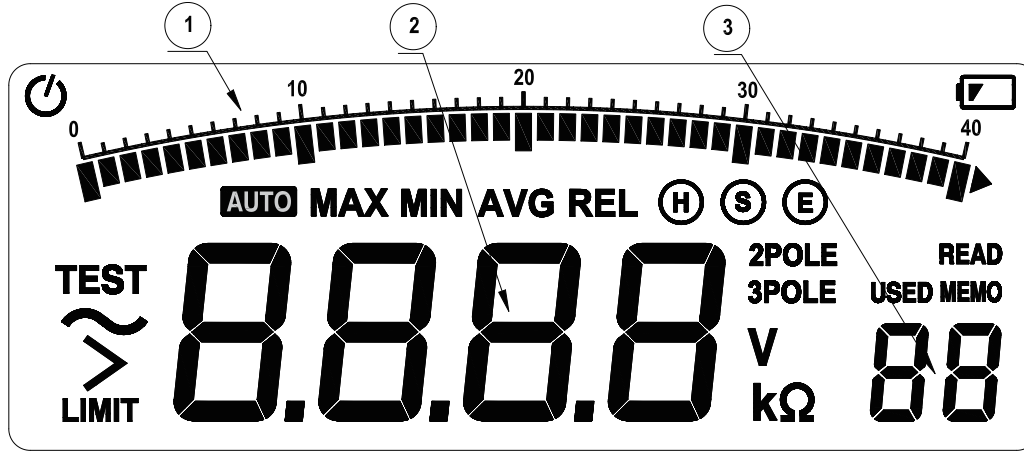





- (1) Simulating bar
- (2) Display of saved data
- (3) Display of memory cell used for data storage

Descriptions of symbols on LCD:

- TEST: a test is underway
- >LIMIT : measuring limit has been exceeded

ERT100 Digital Earth Resistance Tester

- MAX : Maximum
- MIN : Minimum
- AVG : Average
- REL : Relative measurement
- READ : Data reading
- MEMO : Data is being put into a memory
- USED : There are data in memories.
- 2POLE : 2-pole method is being used for measurement of resistance.
- 3POLE : 3-pole method is being used for measurement of resistance.
- V : Volt(voltage)
- K Ω : Ohm(resistance)
-  : Auto power-off has been activated
-  : Battery is low with the symbol on
-  : For socket identification
-  : Alternating current
-  : For warnings and cautions

ERT100 Digital Earth Resistance Tester

3. Specifications

Air temperature: 23 ± 5 C Relative humidity: <75%

3.1 Range Specifications

	Range	Precisionh
Earth Ground Resistance	0~29.99 Ω	$\pm(2\%rdg+6d)$
	30~99.9 Ω	$\pm(3\%rdg+3d)$
	100~999 Ω	$\pm(3\%rdg+3d)$
	1.00~4000 Ω	$\pm(4\% rdg +4d)$
Earth Voltage	AC 0~200V (50Hz/60Hz)	$\pm(2\% rdg +4d)$

3.2 Measurement method

Constant Current Conversion is used for the measurement of earth resistance, with the frequency of the testing current about 800HZ and the size about 3mA.

Average rectification is used for the measurement of earth voltage.

3.3 Temperature and humidity for measurement

0~40 C , relative humidity under 85%

3.4 Temperature and humidity for keeping the meter

-10~50 C , relative humidity under 85%

3.5 Battery

6x 1.5V AA batteries

3.6 Volume

13 x 4.9 x 10.4 inches (330 X 125 X 265mm)

3.7 Weight

7.6 pounds (3.45kg)

3.8 Supplied accessories

Three test leads (one 15-meter-long red lead, one 10-meter-long green lead and one 5-meter-long black lead) , 2auxiliary earth bars

ERT100 Digital Earth Resistance Tester

4. Operation Instruction

⚠ Danger

In measurement of earth voltage, do not exert voltage above AC220V on the measurement port.

In measurement of earth resistance, there will occur potential of about 50 V between port E and S or between ports E and C, therefore, protect yourself from electrical shock.

Before using the meter, check the electricity in the battery by turning on the meter, checking if there is “” on display and replace the battery by following the steps described in Chapter “Replacement of the battery” if the symbol exists.

4.1 Measurement of earth voltage

Rotate the switch to ~VE position, insert the ends of measuring cords into sockets E and S, and place the other ends across the earth voltage measuring points. If there is voltage, it will be displayed on LCD.

4.2 How to measure earth resistance by 2-pole method

Existing earth points, such as buried metals (metal water pipe etc), common earth of the commercial power supply or lightning rods of high buildings, are used as the auxiliary pole in this method.

ERT100 Digital Earth Resistance Tester

(1) Test Connection Diagram

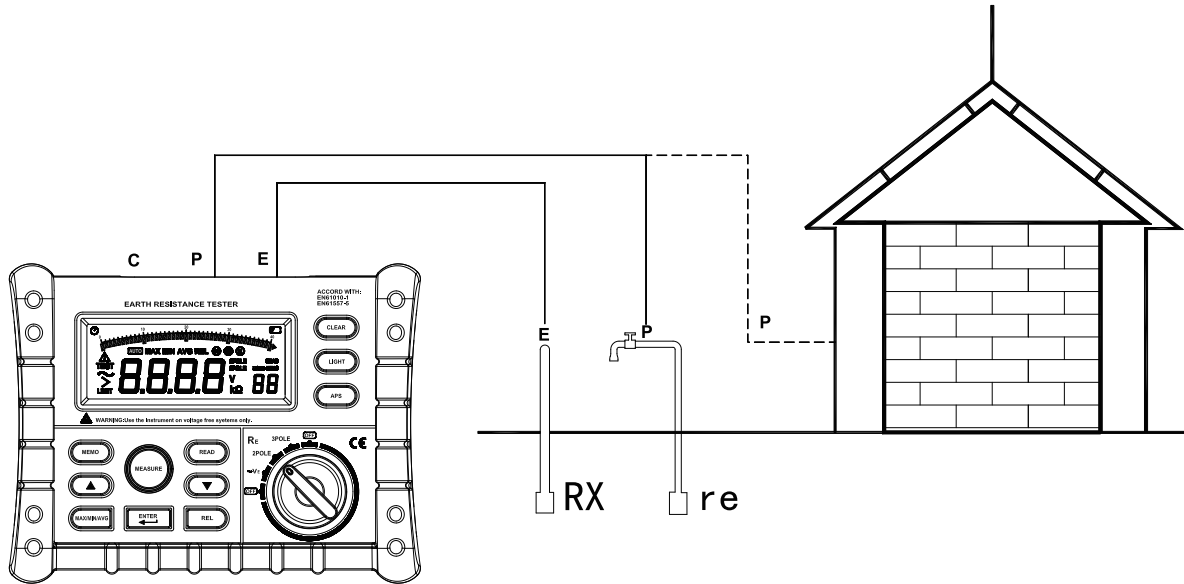

ERT100 Digital Earth Resistance Tester

(2) Measurement of earth voltage.

Earth voltage measurement should be done before measurement of earth resistance to check the amount of earth voltage, as voltage more than 10 V is likely to cause larger error in the measurement of earth resistance. In this case, cut the measured object from the power supply and wait until the earth voltage drop for another measurement.

(3) Measurement of earth resistance

Rotate the switch to the 2POLE position, press MEASURE key to start the measurement, (the key will light up and be blinking). When the measurement completes automatically, a beep will sound and the MEASURE key light will go off. The data will be held automatically.

Attention: >LIMIT4000 displayed on LCD warns that the auxiliary earth resistance of the auxiliary earth rods is so high that the current can not flow across the meter. Check if the test leads become loose. and the amount of the earth resistance of the auxiliary earth rods. Delete*

(4) Value measured

R_e , value of the earth resistance measured by 2-pole method, equals the sum of r_e , the earth resistance of earth rods, and R_X , the real earth resistance of the object measured; therefore, $R_X = R_e - r_e$, meaning that the real resistance of the object measured equals R_e minus r_e .

4.3 Measurement of the resistance by 3-pole method

The Fall of Potential Method is used by the meter for the measurement of the earth resistance. Particularly, R_X , the earth resistance is calculated by allowing I , the rated current to flow between E, (the earth rods) and C, the current pole, then measuring V , the voltage across E and P, (the voltage pole).

ERT100 Digital Earth Resistance Tester

(1) Connect the test leads to the meter as follows

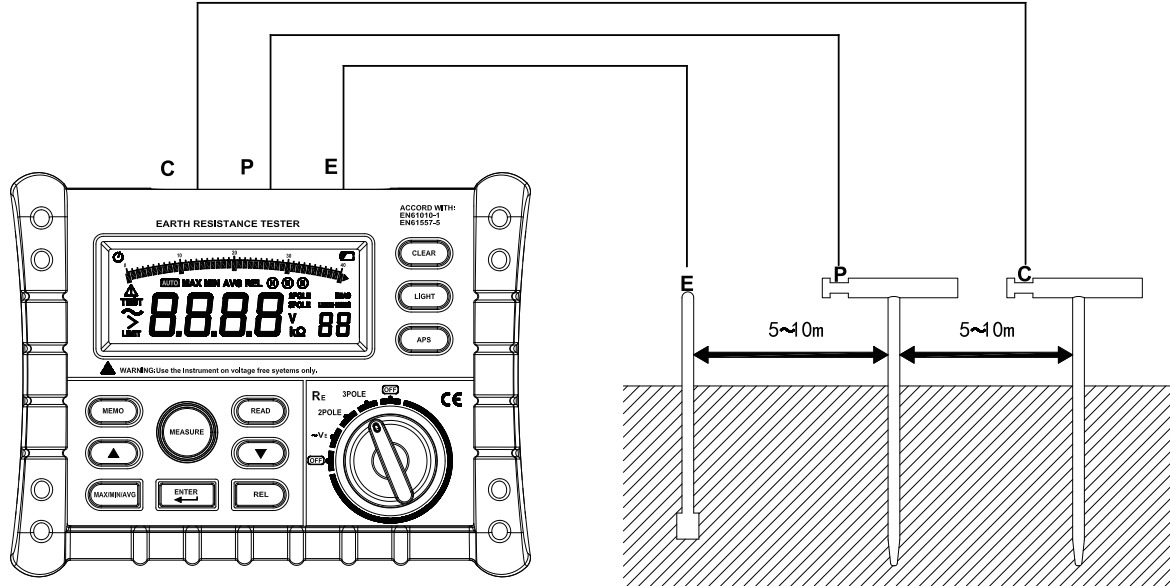

Fully insert the Auxiliary Earth Bars P, C in straight line into the ground and ensure that the bars are between 5 and 10 meters apart.

Connect ends of the test leads (black, red and green), from the ports E, P, C, separately to the object measured, auxiliary earth rod P and auxiliary earth C.

Attention: Drive the auxiliary rods where the earth is damp; If no soil other than clay, sand or gravel, which are dry, are available, spray some water onto them to keep them damp; in case the measurement is performed on a concrete floor, place the auxiliary earth rods horizontally and spray some water onto them or cover them with damp cloth.

ERT100 Digital Earth Resistance Tester

(2) Measurement of earth voltage

Earth voltage measurement should be done before resistance, as voltage more than 10 V is likely to cause larger error in the measurement of earth resistance. In this case, remove the test leads and wait until the earth voltage drop for another measurement.

(3) Measurement of earth resistance

Rotate the switch to 3 POL position, press down the MEASURE key to start the measurement. The MEASURE key will come on and blink. When the measurement is complete the beeper will give a sound, the key light will go off and the data will be held automatically.

Attention: > LIMIT4000Ω displayed on LCD warns that the auxiliary earth resistance of the auxiliary earth rods is so high that the current can not flow across the meter. Check if the test leads become loose and the amount of the earth resistance of the auxiliary earth rods. Make sure that a measurement is done when the test leads are separated. Solidly insert auxiliary earth rods such as P and C in damp locations and ensure good connection at each rod.

4.4 Non-volatile Data Storage

The meter is capable of storing up to 100 groups of measurement data, which will not be lost even in case of power loss.

- (1) When the meter is idle, press MEMO to call for data storage, with "MEMO" blinking at the lower right corner of LCD. Should the memory have been previously used, "USED" would be shown on LCD. Press MEMO to exit data storage.
- (2) Press "ENTER" briefly to switch memory positions and 10-bit and the memory position can be scanned by pressing ▲ or ▼.
- (3) Press "ENTER" for 2 seconds to store a group of data in memory over-writing previous entries.

4.5 Data Recall

Data recall allows you to check the historical data stored in the meter.

- (1) When the meter is idle, press MEMO for Data Recall. Should the existing memory have been used for storage of other data, "USED" would be shown on LCD. Press MEMO to exit data storage.
- (2) Press "ENTER" briefly to scan data cells by pressing ▲ or ▼.
- (3) Press "ENTER" for 2 seconds to read a group of data previously stored in the memory.

ERT100 Digital Earth Resistance Tester

4.6 REL—Relative Measurement

Relative measurement is used for direct measurement of earth resistance. Press REL to switch in and out of relative measurement mode.

- (1) In relative measurement mode, the symbol “REL” is shown on LCD and the existing reading is stored in the memory for future reference. In the following relative measurement, what the LCD displays is the difference between the input value and the reference value, that is, existing reading=input value-reference value.
- (2) Under normal measurement of earth resistance, it is not allowed to enter REL mode when the measurement is underway.
- (3) It is not allowed to enter REL mode when the data is being read or stored.
- (4) It is not allowed to enter REL mode when the existing reading exceeds the limit.

4.7 MAX/MIN/AVG Measurement

Press the MAX/MIN/AVG key to switch the modes between the measurements of maximum, minimum, average and normal, corresponding to each of which a symbol is shown on LCD.

- (1) When MAX is selected, the LCD shows the maximum of all the data.
- (2) When MIN is selected, the LCD shows the minimum of all the data.
- (3) When AVG is selected, the LCD shows the average of all the data.

4.8 Data Deletion

The data can be deleted when READ or MEMO is pressed down. Press CLEAR briefly to delete the data stored in the existing position and press it long to delete all the data stored.

4.9 Backlight

Press LIGHT to immediately turn on or turn off the backlight The backlight will go off automatically 15 seconds after it is turned on.

4.10 Auto off

Press ASP to start or stop Auto-off. The symbol  shown on the LCD means the Auto-off function has been started and disappearance of the symbol means that the function has been stopped. In case that no operation is performed within 15 minutes after Auto-off is on, the meter goes into sleeping status and the beeper will sound as a reminder. Press any key to wake the meter up. Be sure to set the switch to “OFF” if the meter will not be used for long.

ERT100 Digital Eah Resistance Tester

5. Replacement of Batteries

⚠ Danger

Never replace the batteries while the meter is damp.

Never replace the batteries while the meter is being used. Switch off the meter and disconnect the test leads and earth rods before replacements to avoid electrical shock.

⚠ Attention

Never mingle new batteries with old ones.

Pay attention to the polarity of the batteries in replacements.

5.1 Unscrew the battery cover and remove it.

5.2 Replace the old batteries with new one and pay attention to their polarities.

5.3 Put back the battery cover and screw it.

ERT100 Digital Earth Resistance Tester

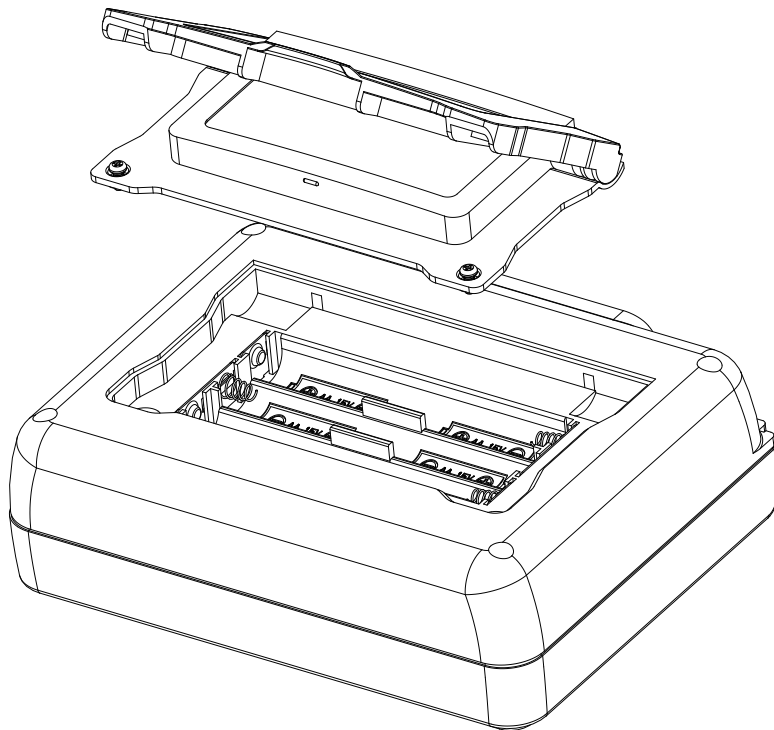

ERT100 Digital Earth Resistance Tester

Armada Technologies

8535 Byron Commerce Dr. SW Suite A
Byron Center, MI 49315

Phone: (616) 803-1080

Fax: (616) 803-1083

www.armadatech.com

